

# LIVING & CO<sup>®</sup>

## HANGING LOUNGER

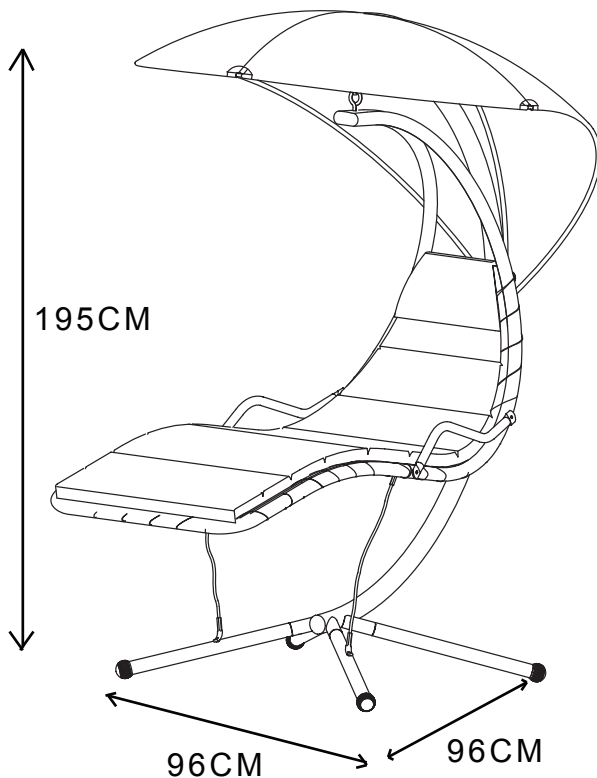

### INSTRUCTION MANUAL

The Maximum Weight this product can hold up to 120 kgs

AFTER SALES SUPPORT

  0800 422 274

## Important Safety Instructions

- This swing must be installed on level ground.
- Assemble 2 meters or more away from obstruction such as fence, house, hot grills, overhanging branches, laundry wires and electrical wires...etc.
- Tighten all nuts, bolts and components during assembly and periodically during usage, fail to do so will be on your own risk.
- Use with proper cautions especially accompany with young children. Gentle swing action is recommended for both adult and young children. Younger children should not be left alone without adult accompany on the swing.
- Maximum weight capacity 120kgs.
- Make sure to have help when removing seat from the frame or when moving the swing.
- No machine wash or dry clean for all the fabric materials, use hand wash with care only

## Assembly Details

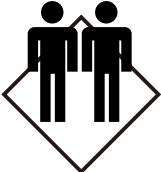
<p><b>60 MIN</b></p> <p>APPROXIMATE ASSEMBLY TIME</p>	<p>2 PERSONS ASSEMBLY</p> 	<p>FLOORAREA 2.0MX2.0M</p>  <p>REQUIRED ASSEMBLY SPACE</p>
---	---	--











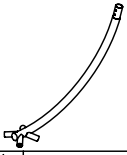

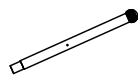
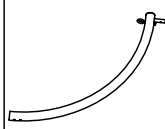



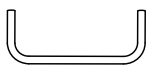
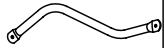
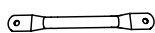





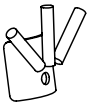
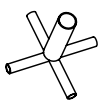

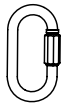
## Tips before you start

1. Please check that all parts are present before you start the assembly of your furniture.
2. For ease and speed of assembly, we recommend that before you commence each step of the assembly, that you identify all the parts required for that step.
3. For larger items, please ensure that you have sufficient space and people (as indicated on page 1) to assemble your product safely.
4. We recommend that, where possible, all items are assembled near to the area in which they will be placed in use, to avoid moving the product unnecessarily once assembled.
5. For the protection of your furniture, we recommend that the product is placed on a protected surface during assembly to prevent any damage.
6. During assembly please take care not to over-tighten any fittings, as this may damage the product. Do not use power tools.
7. Always place the product on a flat, steady and stable surface.
8. Do not stand on the product. Do not use the product as a stepladder.
9. This product is intended household use only as it is a non-industrial product.
10. Please use caution and care when lifting the product to avoid personal injury and/or product damage.

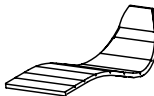
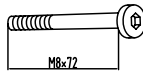
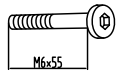
## Care and maintenance

- When left exposed to the elements for a period of time, steel may rust and fabric may fade.
- To prolong the life of your furniture, clean and dry frame regularly.
- Use car polish or similar product for extra protection of metal components. Use spray lubricant or similar on nuts and bolts.
- We recommend storing furniture under cover, out of direct sunlight and using furniture covers when not in use and for protection during the winter months.

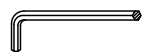
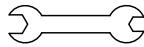
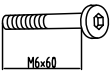
# Part Name

				
A   1	B   2	B1   2	C   1	D   1
				
E   1	F   2	G   1	H   2	I   1
				
J   2	K   3	L   2	M   1	N   2
				
O   1	P   1	Q   1	R   1	S   1
				
T   1	U   1	V   1	W   2	X   4
				
BB   M6/14   M8/4	CC   M6/6   M8/2	DD   M6/6   M8/2	EE   1	FF   1
				
Y   2	Z   2	AA   M6/8   M8/2		

# Assembly

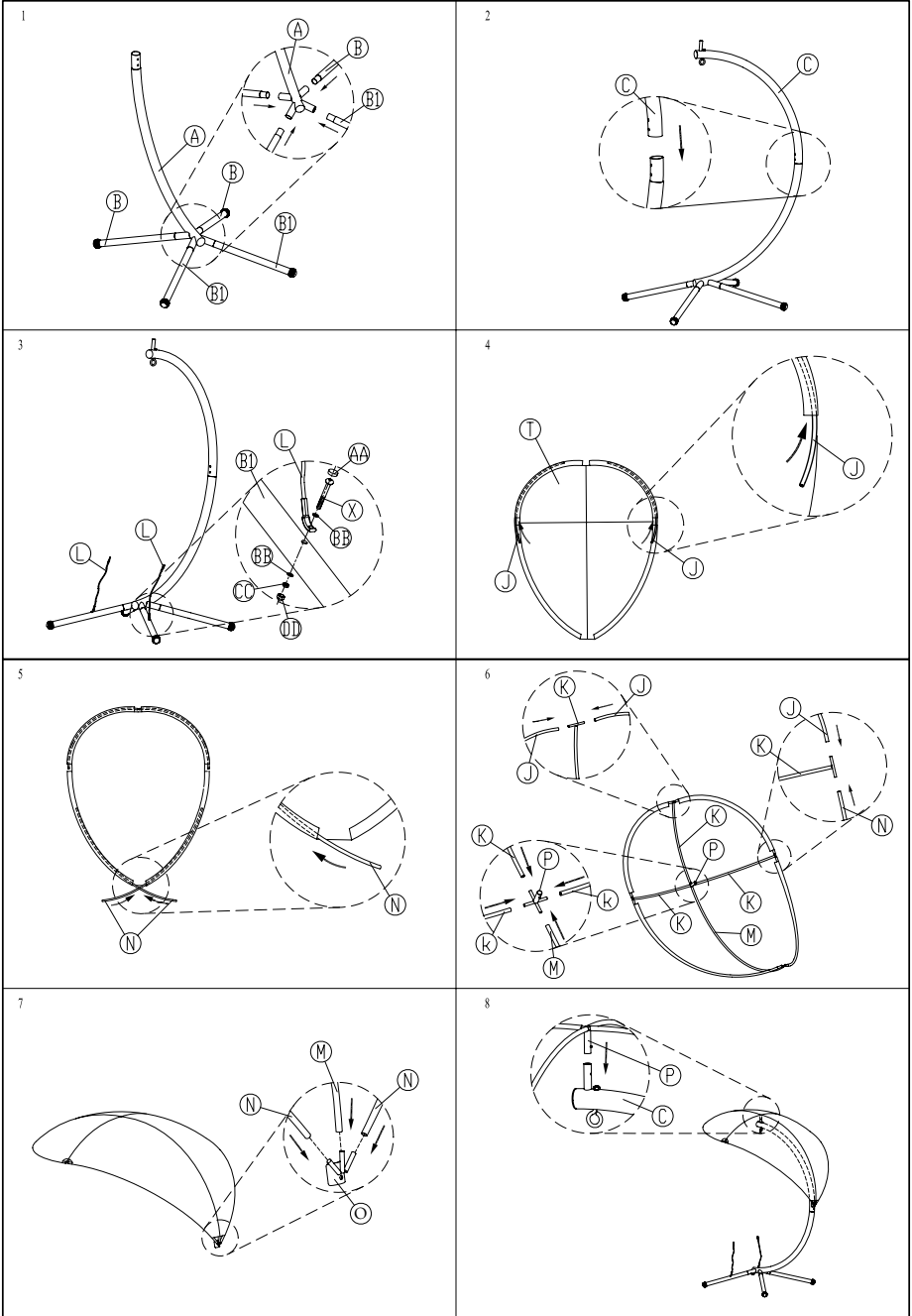

# Assembly

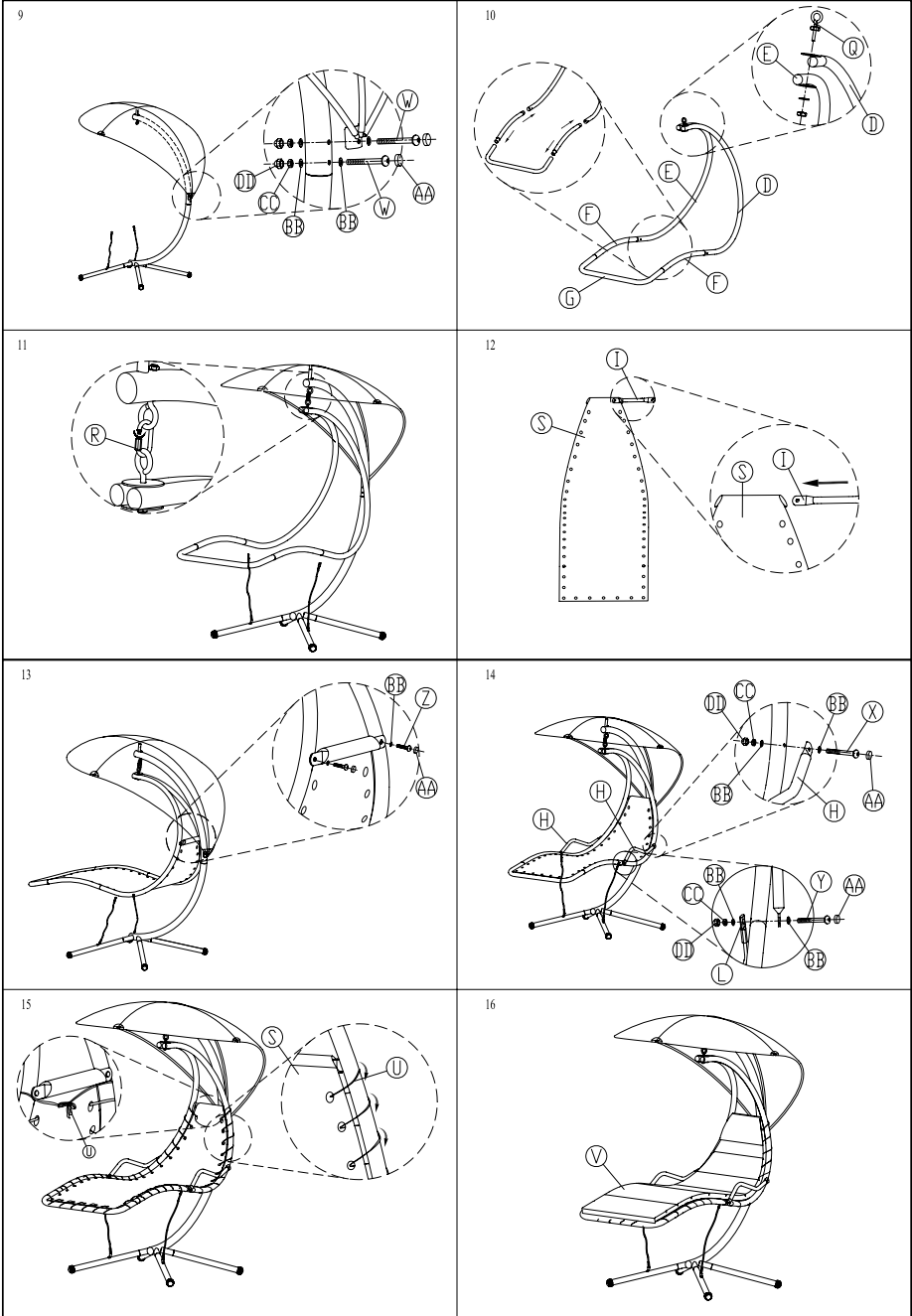



# LIVING & CO<sup>®</sup>

## Warranty

We pride ourselves on producing a range of quality products that are both packed with features and completely reliable. We are so confident in our products, we back them up with one year warranty.

Now you too can relax knowing that you are covered.

Customer Helpline NZ: 0800 422 274  
This product is covered by one year warranty  
when accompanied by proof of purchase.

---

AFTER SALES SUPPORT

  0800 422 274